

**16A, 50V, 0.047 Ohm, Logic Level,
N-Channel Power MOSFETs**

These are N-Channel logic level power MOSFETs manufactured using the MegaFET process. This process, which uses feature sizes approaching those of LSI integrated circuits gives optimum utilization of silicon, resulting in outstanding performance. They were designed for use with logic level (5V) driving sources in applications such as programmable controllers, automotive switching, switching regulators, switching converters, motor relay drivers and emitter switches for bipolar transistors. This performance is accomplished through a special gate oxide design which provides full rated conductance at gate biases in the 3V to 5V range, thereby facilitating true on-off power control directly from logic circuit supply voltages.

Formerly developmental type TA09871.

Ordering Information

PART NUMBER	PACKAGE	BRAND
RFD16N05L	TO-251AA	RFD16N05L
RFD16N05LSM	TO-252AA	RFD16N05LSM

NOTE: When ordering, include the entire part number. Add the suffix 9A to obtain the TO-252AA variant in tape and reel, i.e. RFD16N05LSM9A

Features

- 16A, 50V
- $r_{DS(ON)} = 0.047\Omega$
- UIS SOA Rating Curve (Single Pulse)
- Design Optimized for 5V Gate Drives
- Can be Driven Directly from CMOS, NMOS, TTL Circuits
- Compatible with Automotive Drive Requirements
- SOA is Power Dissipation Limited
- Nanosecond Switching Speeds
- Linear Transfer Characteristics
- High Input Impedance
- Majority Carrier Device
- Related Literature
 - TB334 "Guidelines for Soldering Surface Mount Components to PC Boards"

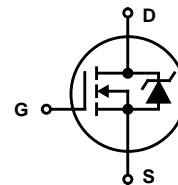
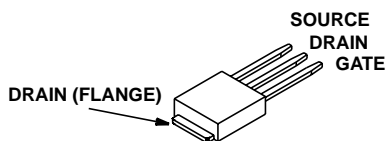
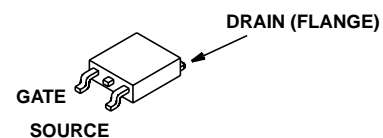
Symbol

Packaging
JEDEC TO-251AA

JEDEC TO-252AA

RFD16N05L, RFD16N05LSM

Absolute Maximum Ratings $T_C = 25^\circ\text{C}$, Unless Otherwise Specified

	RFD16N05L, RFD16N05LSM	UNITS
Drain to Source Voltage (Note 1)	50	V
Drain to Gate Voltage ($R_{GS} = 20k\Omega$) (Note 1)	50	V
Continuous Drain Current	16	A
Pulsed Drain Current (Note 3)	45	A
Gate to Source Voltage	± 10	V
Maximum Power Dissipation	60	W
Derate Above 25°C	0.48	W/ $^\circ\text{C}$
Operating and Storage Temperature	-55 to 150	$^\circ\text{C}$
Maximum Temperature for Soldering		
Leads at 0.063in (1.6mm) from Case for 10s	300	$^\circ\text{C}$
Package Body for 10s, See Techbrief 334	260	$^\circ\text{C}$

CAUTION: Stresses above those listed in "Absolute Maximum Ratings" may cause permanent damage to the device. This is a stress only rating and operation of the device at these or any other conditions above those indicated in the operational sections of this specification is not implied.

NOTE:

1. $T_J = 25^\circ\text{C}$ to 125°C .

Electrical Specifications $T_C = 25^\circ\text{C}$, Unless Otherwise Specified

PARAMETER	SYMBOL	TEST CONDITIONS	MIN	TYP	MAX	UNITS	
Drain to Source Breakdown Voltage	BV_{DSS}	$I_D = 250\text{mA}$, $V_{GS} = 0\text{V}$, Figure 10	50	-	-	V	
Gate to Threshold Voltage	$V_{GS(TH)}$	$V_{GS} = V_{DS}$, $I_D = 250\text{mA}$, Figure 9	1	-	2	V	
Zero Gate Voltage Drain Current	I_{DSS}	$V_{DS} = 40\text{V}$, $V_{GS} = 0\text{V}$ $T_C = 150^\circ\text{C}$	-	-	1	μA	
			-	-	50	μA	
Gate to Source Leakage Current	I_{GSS}	$V_{GS} = \pm 10\text{V}$, $V_{DS} = 0\text{V}$	-	-	100	nA	
Drain to Source On Resistance (Note 2)	$r_{DS(ON)}$	$I_D = 16\text{A}$, $V_{GS} = 5\text{V}$	-	-	0.047	Ω	
		$I_D = 16\text{A}$, $V_{GS} = 4\text{V}$	-	-	0.056	Ω	
Turn-On Time	$t_{(ON)}$	$V_{DD} = 25\text{V}$, $I_D = 8\text{A}$, $V_{GS} = 5\text{V}$, $R_{GS} = 12.5\Omega$ Figures 15, 16	-	-	60	ns	
Turn-On Delay Time	$t_{d(ON)}$		-	14	-	ns	
Rise Time	t_r		-	30	-	ns	
Turn-Off Delay Time	$t_{d(OFF)}$		-	42	-	ns	
Fall Time	t_f		-	14	-	ns	
Turn-Off Time	$t_{(OFF)}$		-	-	-	100	ns
Total Gate Charge	$Q_g(TOT)$	$V_{GS} = 0\text{V}$ to 10V	$V_{DD} = 40\text{V}$, $I_D = 16\text{A}$, $R_L = 2.5\Omega$ Figures 17, 18	-	-	80	nC
Gate Charge at 5V	$Q_g(5)$	$V_{GS} = 0\text{V}$ to 5V		-	-	45	nC
Threshold Gate Charge	$Q_g(TH)$	$V_{GS} = 0\text{V}$ to 1V		-	-	3	nC
Thermal Resistance Junction to Case	$R_{\theta JC}$		-	-	2.083	$^\circ\text{C/W}$	
Thermal Resistance Junction to Ambient	$R_{\theta JA}$		-	-	100	$^\circ\text{C/W}$	

Source to Drain Diode Specifications

PARAMETER	SYMBOL	TEST CONDITIONS	MIN	TYP	MAX	UNITS
Source to Drain Diode Voltage	V_{SD}	$I_{SD} = 16\text{A}$	-	-	1.5	V
Diode Reverse Recovery Time	t_{rr}	$I_{SD} = 16\text{A}$, $di_{SD}/dt = 100\text{A}/\mu\text{s}$	-	-	125	ns

NOTES:

2. Pulse Test: Pulse Width $\leq 300\text{ms}$, Duty Cycle $\leq 2\%$.
3. Repetitive Rating: Pulse Width limited by max junction temperature.

Typical Performance Curves Unless Otherwise Specified

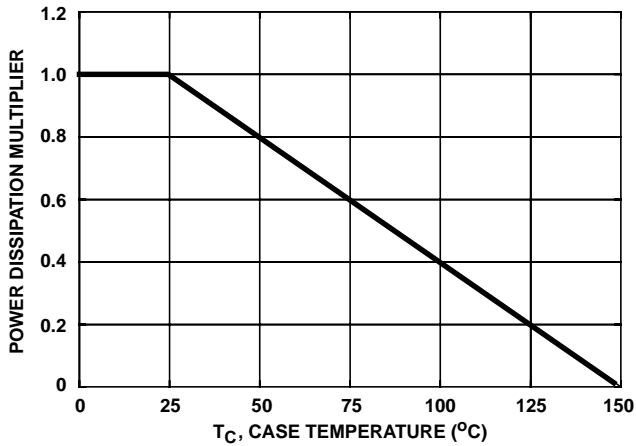

FIGURE 1. NORMALIZED POWER DISSIPATION vs CASE TEMPERATURE

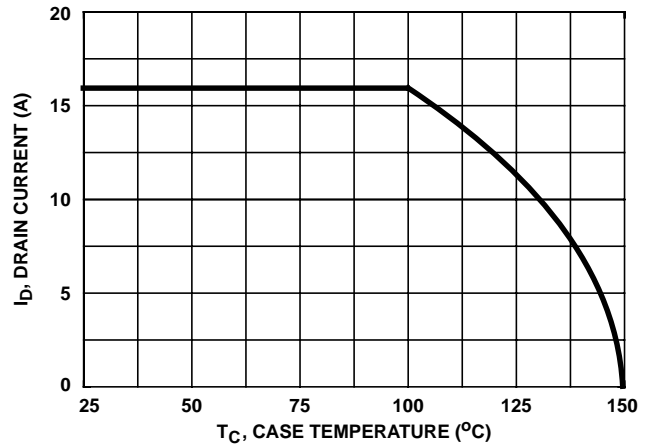

FIGURE 2. MAXIMUM CONTINUOUS DRAIN CURRENT vs CASE TEMPERATURE

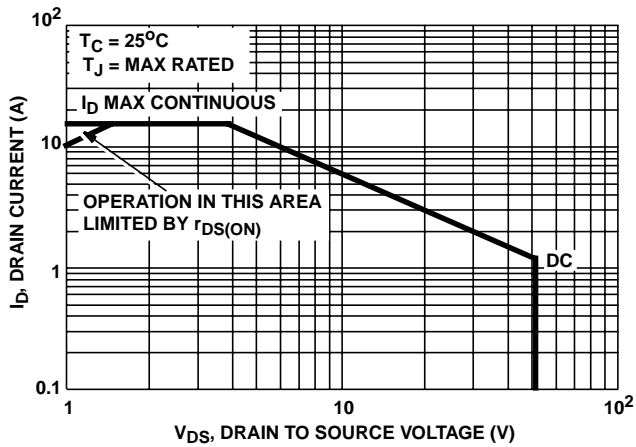

FIGURE 3. FORWARD BIAS SAFE OPERATING AREA

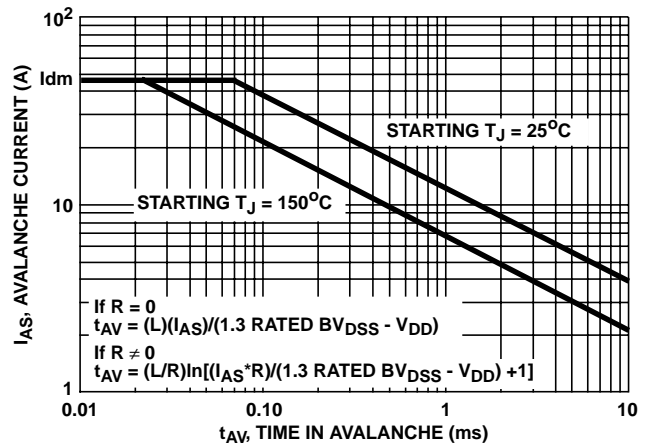

FIGURE 4. UNCLAMPED INDUCTIVE SWITCHING SOA (SINGLE PULSE UIS SOA)

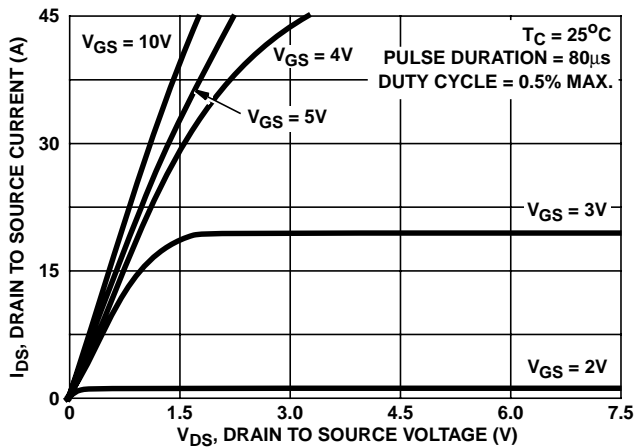

FIGURE 5. SATURATION CHARACTERISTICS

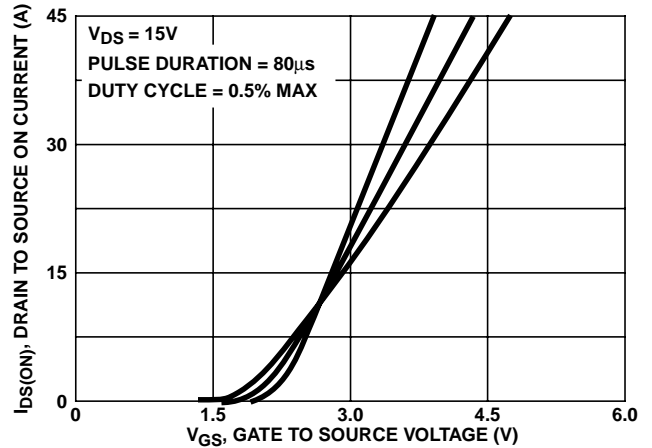

FIGURE 6. TRANSFER CHARACTERISTICS

Typical Performance Curves Unless Otherwise Specified (Continued)

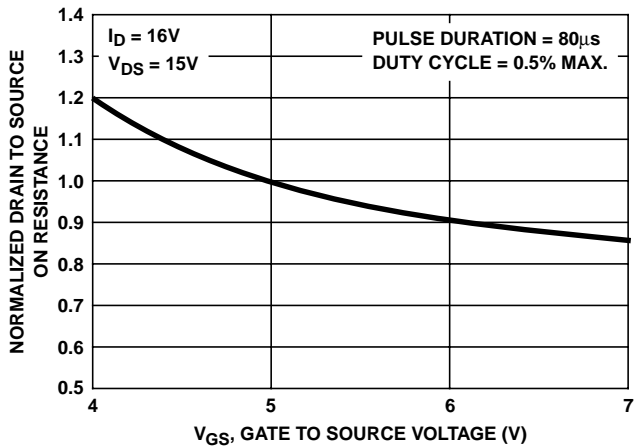

FIGURE 7. DRAIN TO SOURCE ON RESISTANCE vs GATE VOLTAGE AND DRAIN CURRENT

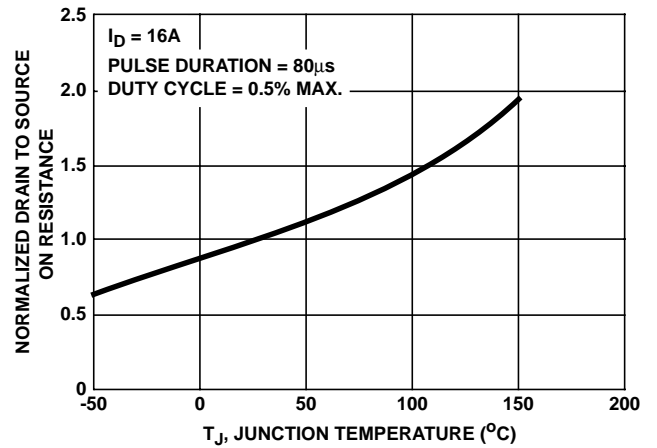

FIGURE 8. NORMALIZED DRAIN TO SOURCE ON RESISTANCE vs JUNCTION TEMPERATURE

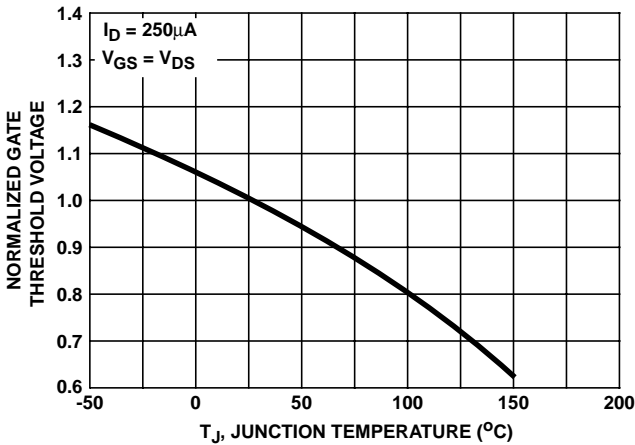

FIGURE 9. NORMALIZED GATE THRESHOLD vs JUNCTION TEMPERATURE

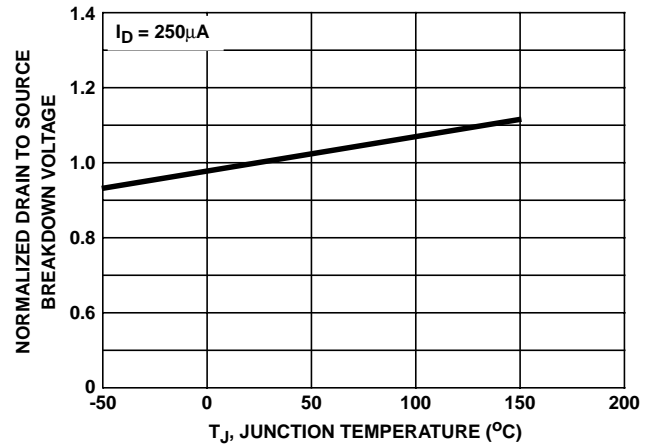

FIGURE 10. NORMALIZED DRAIN TO SOURCE BREAKDOWN VOLTAGE vs JUNCTION TEMPERATURE

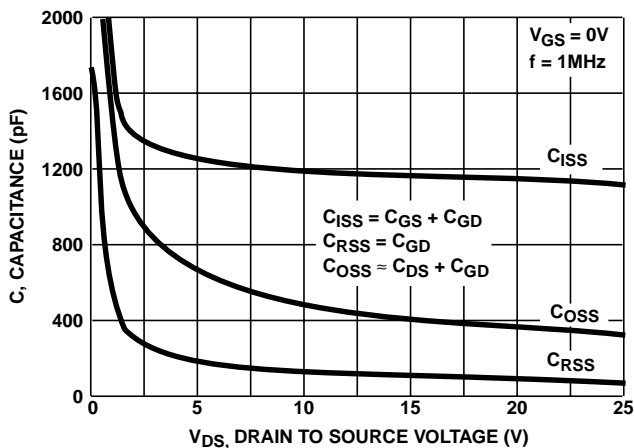

FIGURE 11. CAPACITANCE vs DRAIN TO SOURCE VOLTAGE

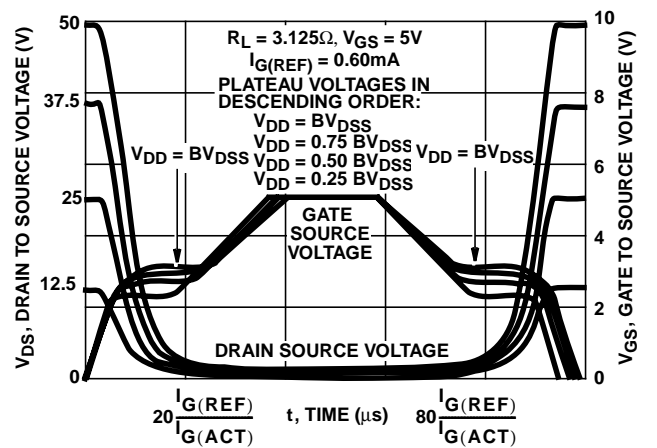

FIGURE 12. NORMALIZED SWITCHING WAVEFORMS FOR CONSTANT GATE CURRENT

Test Circuits and Waveforms

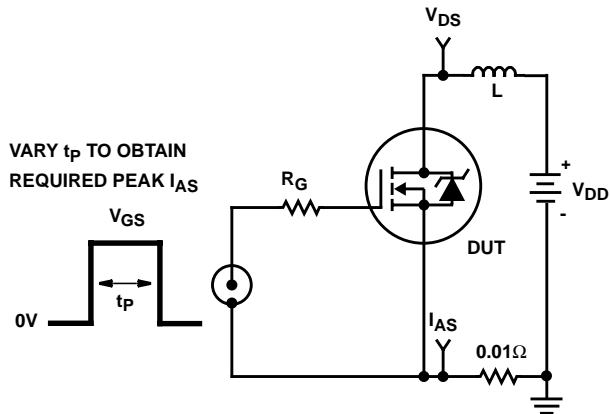

FIGURE 13. UNCLAMPED ENERGY TEST CIRCUIT

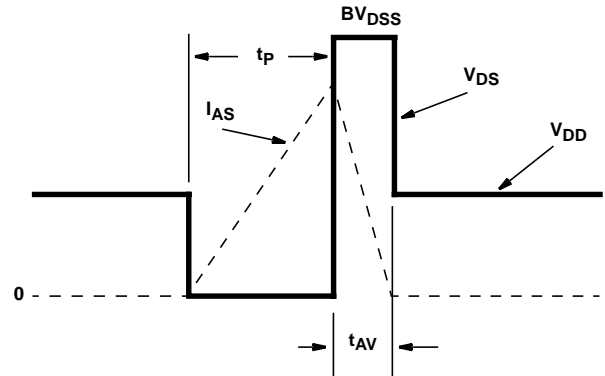

FIGURE 14. UNCLAMPED ENERGY WAVEFORMS

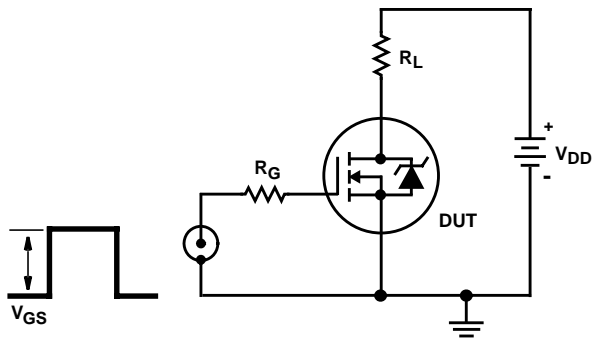

FIGURE 15. SWITCHING TIME TEST CIRCUIT

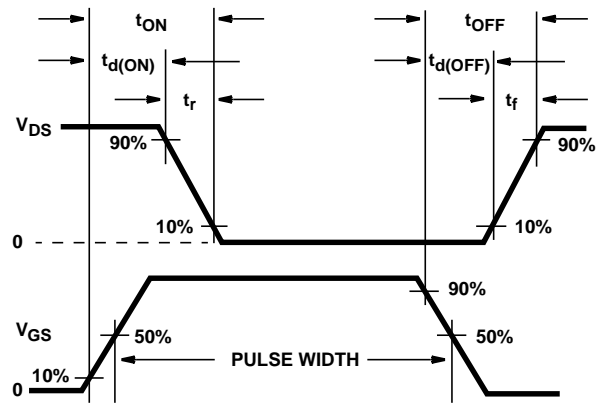

FIGURE 16. RESISTIVE SWITCHING WAVEFORMS

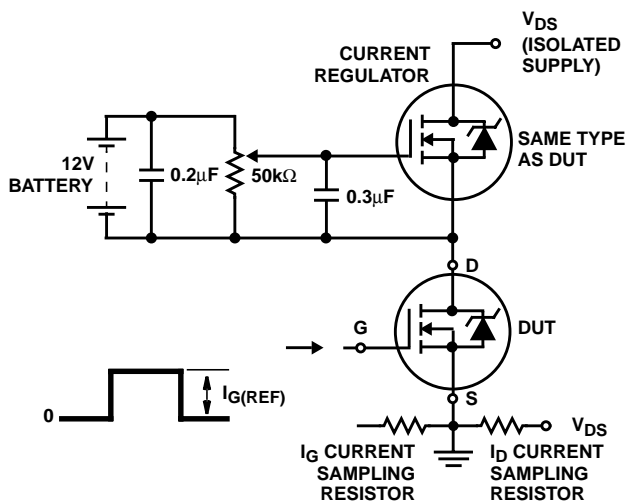

FIGURE 17. GATE CHARGE TEST CIRCUIT

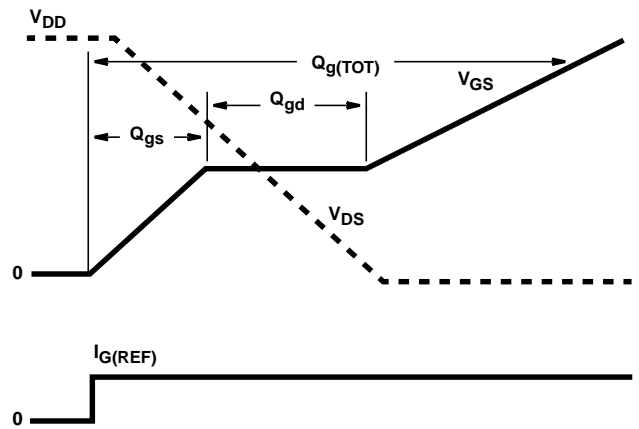

FIGURE 18. GATE CHARGE WAVEFORMS

Spice Model (RFD16N05L)

```
.SUBCKT RFD16N05L 2 1 3; rev 04/08/92
*Nominal Temperature = 25°C
.MODEL MOSMOD NMOS (VTO=2.054 KP=24.73 IS=1e-30 N=10 TOX=1 L=1u W=1u)
Vto 21 6 0.448
Rsource 8 7 RDSMOD 0.614E-3
Rdrain 5 16 RDSMOD 27.38E-3
.MODEL RDSMOD RES (TC1=3.66E-3 TC2=1.46E-5)
.MODEL RVTOMOD RES (TC1=-1.81E3 TC2=1.41E-6)
Ebreak 11 7 17 18 70.9
.MODEL RBKMOD RES (TC1=1.01E-3 TC2=5.21E-8)
.MODEL DBKMOD D (RS=8.82E-2 TRS1=-2.01E-3 TRS2=7.32E-10)
.MODEL DBDMOD D (IS=1.34E-13 RS=1.21E-2 TRS1=1.64E-3 TRS2=2.59E-6 +CJO=1.13E-9 TT=4.14E-8)
Cin 6 8 1.21E-9
Ca 12 8 3.33E-9
.MODEL S1AMOD VSWITCH (RON=1e-5 ROFF=0.1 VON=-4.25 VOFF=-2.25)
.MODEL S1BMOD VSWITCH (RON=1e-5 ROFF=0.1 VON=-2.25 VOFF=-4.25)
.MODEL DPLCAPMOD D (CJO=5.22E-10 IS=1e-30 N=10)
Cb 15 14 3.11E-9
.MODEL S2AMOD VSWITCH (RON=1e-5 ROFF=0.1 VON=-0.65 VOFF=4.35)
.MODEL S2BMOD VSWITCH (RON=1e-5 ROFF=0.1 VON=4.35 VOFF=-0.65)
Rgate 9 20 2.98
Lgate 1 9 1.38E-9
Ldrain 2 5 1.0E-12
Lsource 3 7 1.0E-9
Dbody 7 5 DBDMOD
Dbreak 5 11 DBKMOD
Dplcap 10 5 DPLCAPMOD
Eds 14 8 5 8 1
Egs 13 8 6 8 1
Esg 6 10 6 8 1
Evto 20 6 18 8 1
It 8 17 1
MOS1 16 6 8 8 MOSMOD M=0.99
MOS2 16 21 8 8 MOSMOD M=0.01
Rbreak 17 18 RBKMOD 1
Rin 6 8 1e9
Rvto 18 19 RVTOMOD 1
S1a 6 12 13 8 S1AMOD
S1b 13 12 13 8 S1BMOD
S2a 6 15 14 13 S2AMOD
S2b 13 15 14 13 S2BMOD
Vbat 8 19 DC 1
.ENDS
x
```

All Intersil semiconductor products are manufactured, assembled and tested under **ISO9000** quality systems certification.

Intersil semiconductor products are sold by description only. Intersil Corporation reserves the right to make changes in circuit design and/or specifications at any time without notice. Accordingly, the reader is cautioned to verify that data sheets are current before placing orders. Information furnished by Intersil is believed to be accurate and reliable. However, no responsibility is assumed by Intersil or its subsidiaries for its use; nor for any infringements of patents or other rights of third parties which may result from its use. No license is granted by implication or otherwise under any patent or patent rights of Intersil or its subsidiaries.

For information regarding Intersil Corporation and its products, see web site <http://www.intersil.com>