

**HEXFET® Power MOSFET**

- Dynamic dv/dt Rating
- Current Sense
- 175°C Operating Temperature
- Fast Switching
- Ease of Paralleling
- Simple Drive Requirements

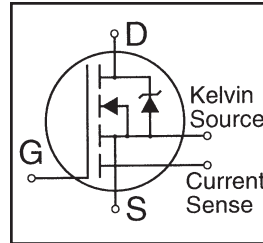

$V_{DSS} = 60V$
$R_{DS(on)} = 0.028\Omega$
$I_D = 50^*A$

**Description**

Third Generation HEXFETs from International Rectifier provide the designer with the best combination of fast switching, ruggedized device, low on-resistance and cost-effectiveness.

The HEXSense device provides an accurate fraction of the drain current through the additional two leads to be used for control or protection of the device. These devices exhibit similar electrical and thermal characteristics as their IRF-series equivalent part numbers. The provision of a kelvin source connection effectively eliminates problems of common source inductance when the HEXSense is used as a fast, high-current switch in non current-sensing applications.

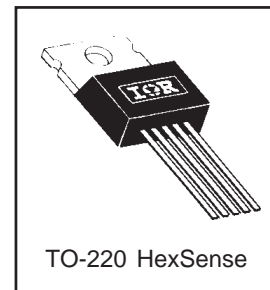

**Absolute Maximum Ratings**

Parameter		Max.	Units
$I_D @ T_C = 25^\circ C$	Continuous Drain Current, $V_{GS} @ 10V$	50*	A
$I_D @ T_C = 100^\circ C$	Continuous Drain Current, $V_{GS} @ 10V$	37	
$I_{DM}$	Pulsed Drain Current ①	210	
$P_D @ T_C = 25^\circ C$	Power Dissipation	150	W
	Linear Derating Factor	1.0	W/°C
$V_{GS}$	Gate-to-Source Voltage	$\pm 20$	V
$E_{AS}$	Single Pulse Avalanche Energy ②	30	mJ
dv/dt	Peak Diode Recovery dv/dt ③	4.5	V/ns
$T_J$	Operating Junction and	-55 to + 175	°C
$T_{STG}$	Storage Temperature Range		
	Soldering Temperature, for 10 seconds		
	Mounting Torque, 6-32 or M3 screw	10 lbf•in (1.1 N•m)	

**Thermal Resistance**

Parameter	Parameter	Min.	Typ.	Max.	Units
$R_{\theta JC}$	Junction-to-Case	—	—	1.0	°C/W
$R_{\theta CS}$	Case-to-Sink, Flat, Greased Surface	—	0.50	—	
$R_{\theta JA}$	Junction-to-Ambient —	—	—	62	

# IRCZ44

International  
 Rectifier

## Electrical Characteristics @ $T_J = 25^\circ\text{C}$ (unless otherwise specified)

Parameter	Min.	Typ.	Max.	Units	Conditions
$V_{(BR)DSS}$	60	—	—	V	$V_{GS} = 0V, I_D = 250\mu A$
$\Delta V_{(BR)DSS}/\Delta T_J$	—	0.060	—	V/°C	Reference to $25^\circ\text{C}, I_D = 1\text{mA}$
$R_{DS(ON)}$	—	—	0.028	$\Omega$	$V_{GS} = 10V, I_D = 31A$ ④
$V_{GS(th)}$	2.0	—	4.0	V	$V_{DS} = V_{GS}, I_D = 250\mu A$
$g_{fs}$	18	—	—	S	$V_{DS} = 25V, I_D = 31A$
$I_{DSS}$	—	—	25	—	$V_{DS} = 60V, V_{GS} = 0V$
	—	—	250	—	$V_{DS} = 48V, V_{GS} = 0V, T_J = 150^\circ\text{C}$
$I_{GSS}$	—	—	100	—	$V_{GS} = 20V$
	—	—	-100	—	$V_{GS} = -20V$
$Q_g$	—	—	95	—	$I_D = 52A$
$Q_{gs}$	—	—	27	nC	$V_{DS} = 48V$
$Q_{gd}$	—	—	46	—	$V_{GS} = 10V$ , See Fig. 6 and 13 ④
$t_{d(on)}$	—	19	—	—	$V_{DD} = 30V$
$t_r$	—	120	—	—	$I_D = 52A$
$t_{d(off)}$	—	55	—	—	$R_G = 9.1\Omega$
$t_f$	—	86	—	—	$R_D = 0.54\Omega$ , See Fig. 10 ④
$L_D$	—	4.5	—	nH	Between lead, 6 mm (0.25in.) from package and center of die contact
$L_C$	—	7.5	—		
$C_{iss}$	—	2500	—	—	$V_{GS} = 0V$
$C_{oss}$	—	1200	—	pF	$V_{DS} = 25V$
$C_{riss}$	—	200	—	—	$f = 1.0\text{MHz}$ , See Fig. 5
$r$	2460	—	2720	—	$I_D = 52A, V_{GS} = 10V$
$C_{oss}$	—	9.0	—	pF	$V_{GS} = 0V, V_{DS} = 25V, f = 1.0\text{MHz}$

## Source-Drain Ratings and Characteristics

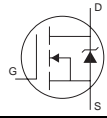
Parameter	Min.	Typ.	Max.	Units	Conditions
$I_S$	—	—	50*	A	MOSFET symbol showing the integral reverse p-n junction diode. 
$I_{SM}$	—	—	210		
$V_{SD}$	—	—	2.5	V	$T_J = 25^\circ\text{C}, I_S = 52A, V_{GS} = 0V$ ④
$t_{rr}$	—	140	300	ns	$T_J = 25^\circ\text{C}, I_F = 52A$
$Q_{rr}$	—	1.2	2.8	nC	$di/dt = 100A/\mu s$ ④
$t_{on}$	Intrinsic turn-on time is negligible (turn-on is dominated by $L_S+L_D$ )				

### Notes:

- ① Repetitive rating; pulse width limited by max. junction temperature. ( See fig. 11 )
- ②  $V_{DD} = 25V$ , starting  $T_J = 25^\circ\text{C}$ ,  $L = 0.013\text{mH}$ ,  $R_G = 25\Omega$ ,  $I_{AS} = 52A$ . (See Figure 12)
- ③  $I_{SD} \leq 52A$ ,  $di/dt \leq 250A/\mu s$ ,  $V_{DD} \leq V_{(BR)DSS}$ ,  $T_J \leq 175^\circ\text{C}$
- ④ Pulse width  $\leq 300\mu s$ ; duty cycle  $\leq 2\%$ .

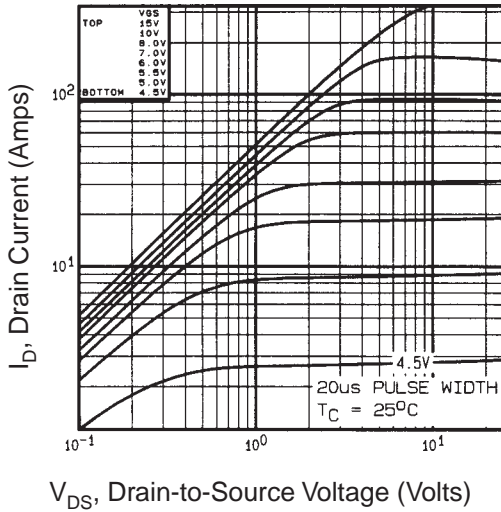

**Fig. 1 Typical Output Characteristics,  
 $T_C=25^\circ\text{C}$**

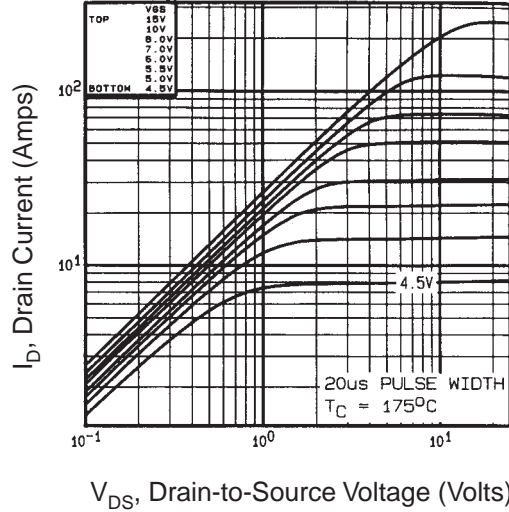

**Fig. 2 Typical Output Characteristics,  
 $T_C=175^\circ\text{C}$**

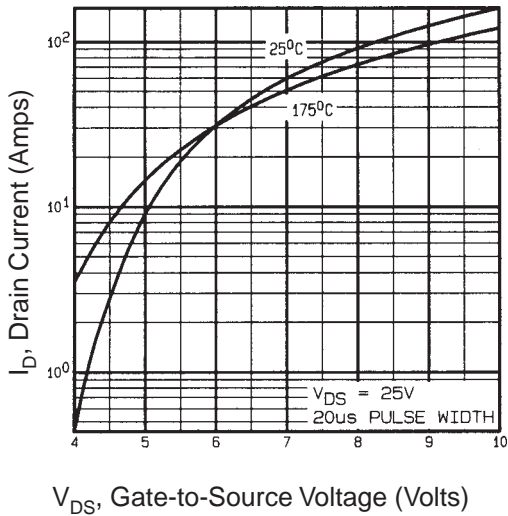

**Fig. 3 Typical Transfer Characteristics**

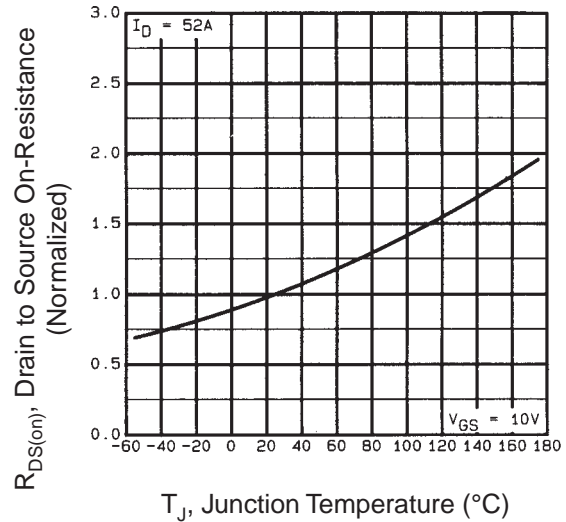

**Fig. 4 Normalized On-Resistance vs.  
 Temperature**

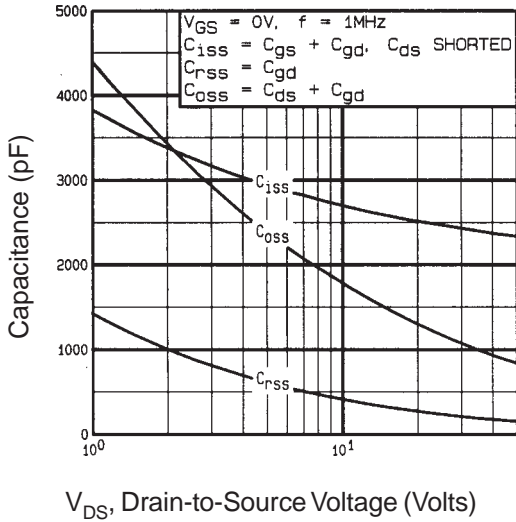

**Fig. 5 Typical Capacitance vs. Drain-to-Source Voltage**

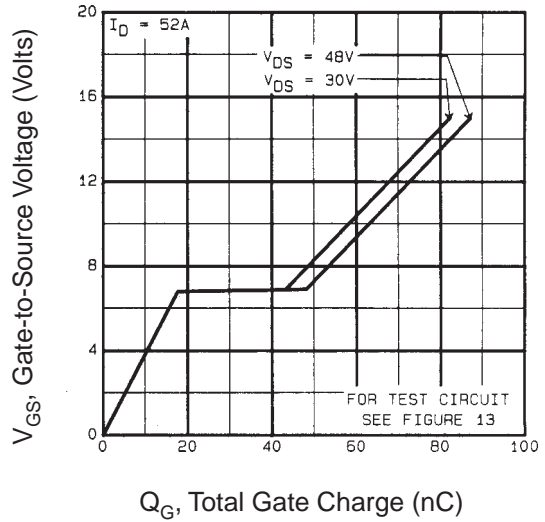

**Fig. 6 Typical Gate Charge vs. Gate-to-Source Voltage**

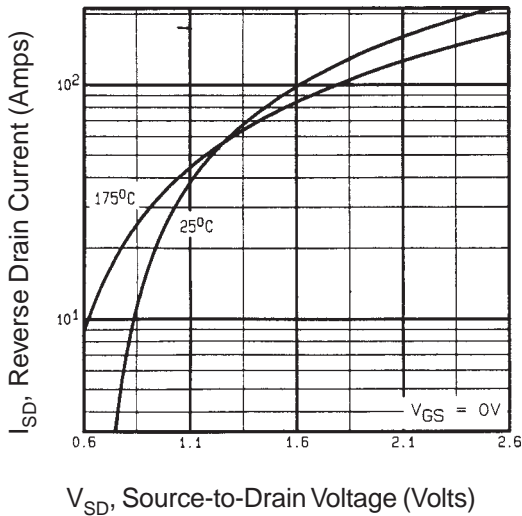

**Fig. 7 Typical Source-Drain Diode Forward Voltage**

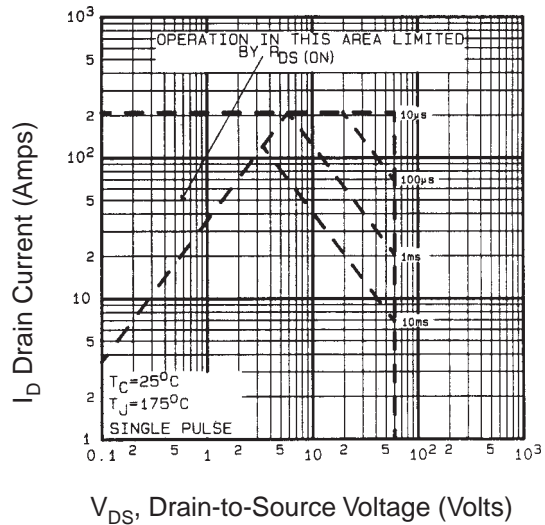

**Fig. 8 Maximum Safe Operating Area**

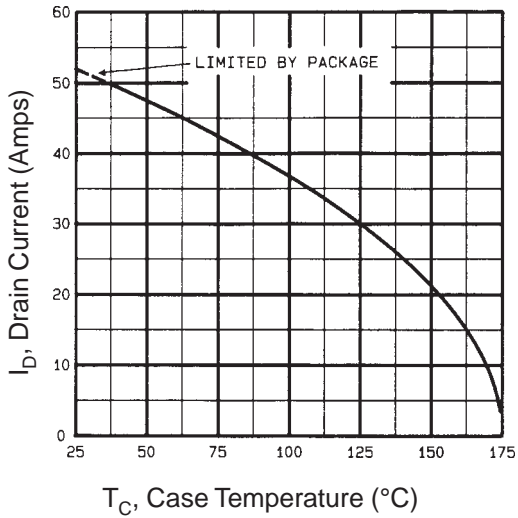

**Fig. 9 Maximum Drain Current vs. Case Temperature**

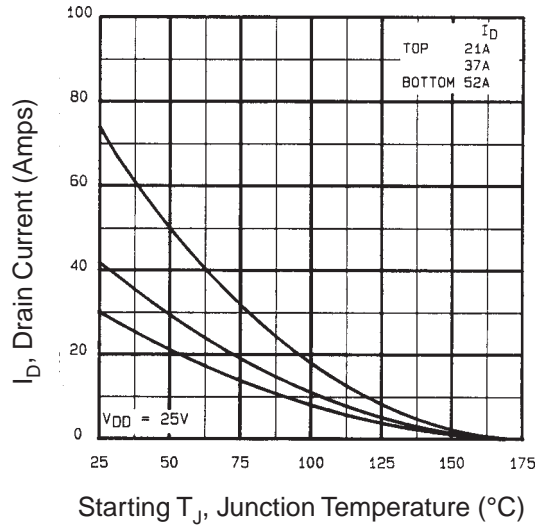

**Fig. 12c Maximum Avalanche Energy vs. Drain Current**

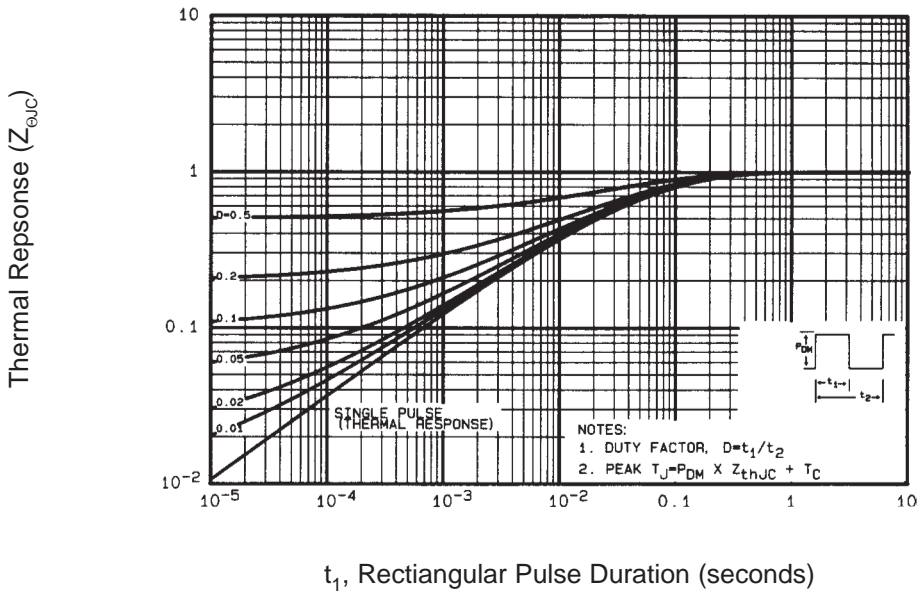

**Fig. 11 Maximum Effective Transient Thermal Impedance, Junction-to-Case**

# IRCZ44

International  
**IR** Rectifier

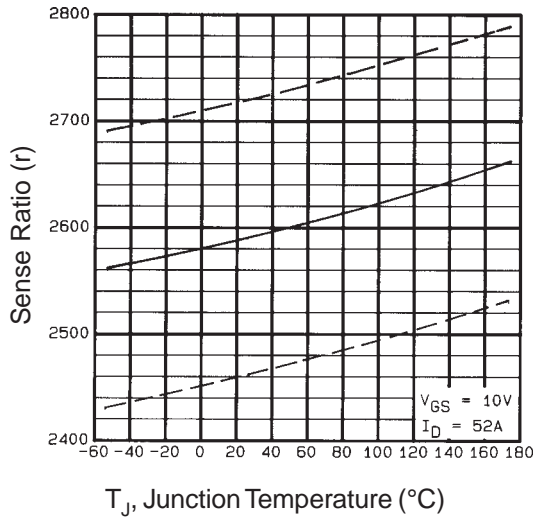

**Fig. 15 Typical HEXSense Ratio vs. Junction Temperature**

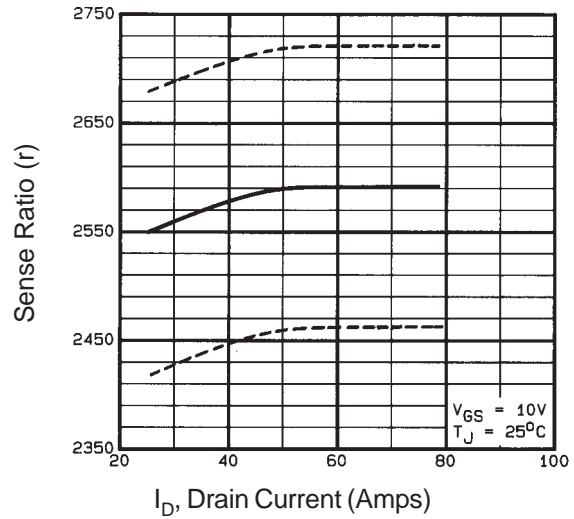

**Fig. 16 Typical HEXSense Ratio vs. Drain Current**

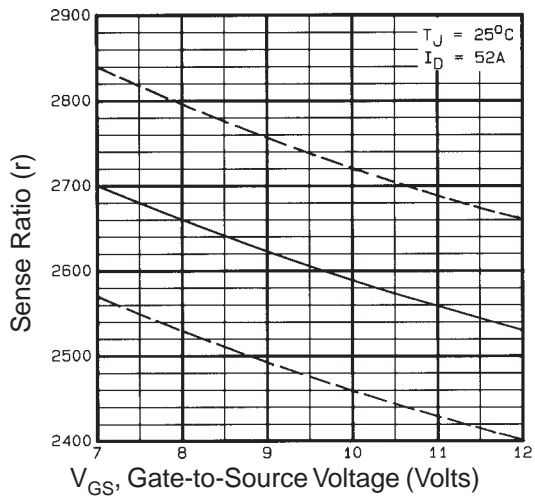

**Fig. 17 Typical HEXSense Ratio vs. Gate Voltage**

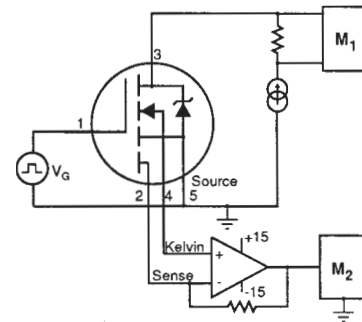

**Fig. 18 HEXSense Ratio Test Circuit**

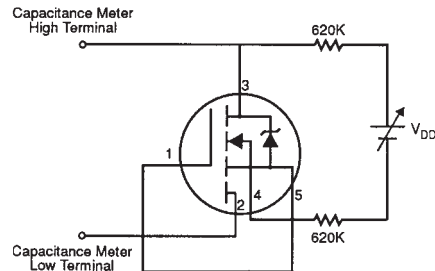

**Fig. 19 HEXSense Sensing Cell Output Capacitance Test Circuit**

Mechanical drawings, Appendix A  
Part marking information, Appendix B  
Test Circuit diagrams, Appendix C